

Die Flächenaussparungen der Rumpfseitenteile sind nur symbolisch!

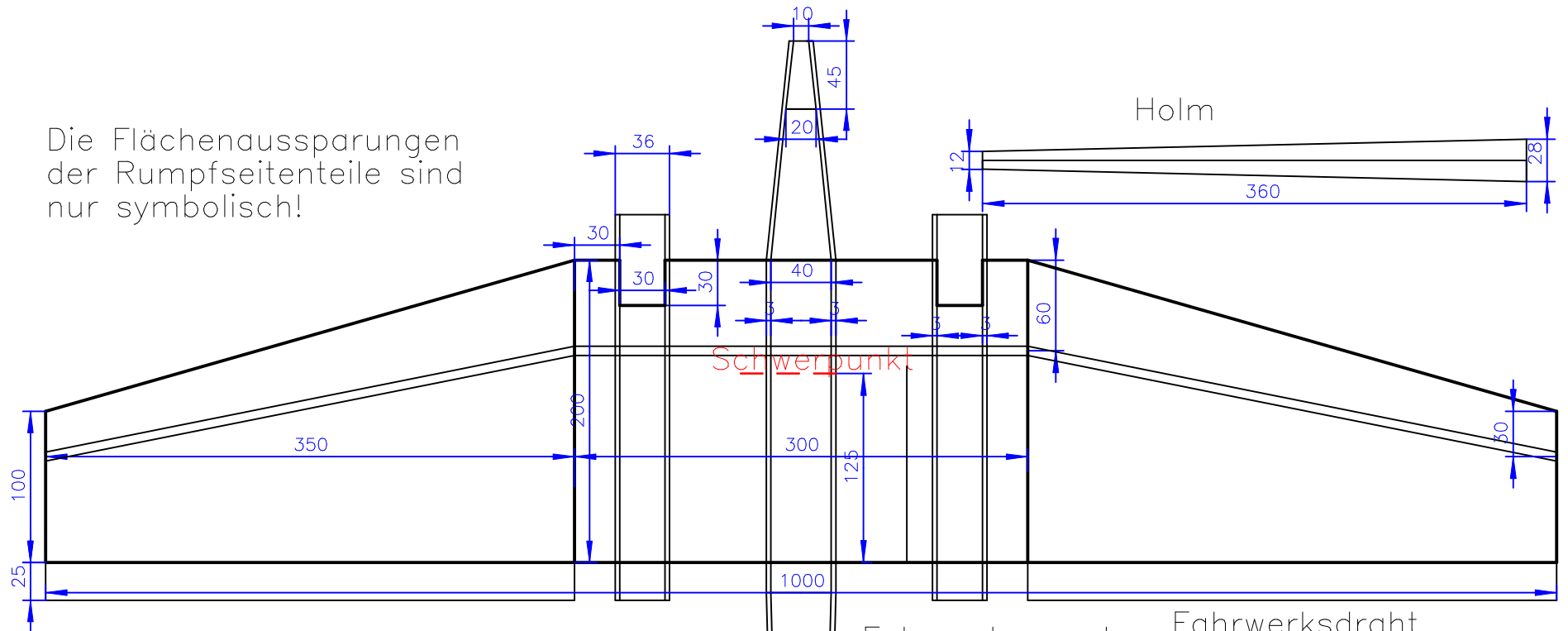

Schwerpunkt

Holm

Motorhalter

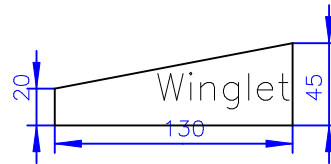
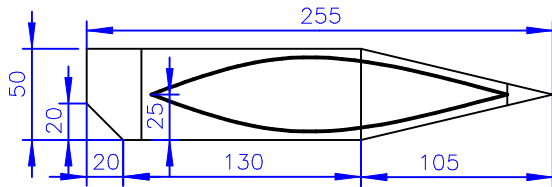

Winglet

Fahrwerksspant

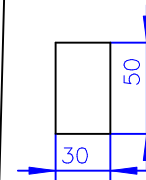

Fahrwerksdraht aus 1mm Federstahl

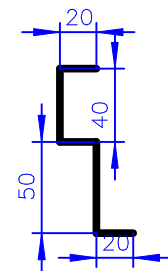

Seitenleitwerk

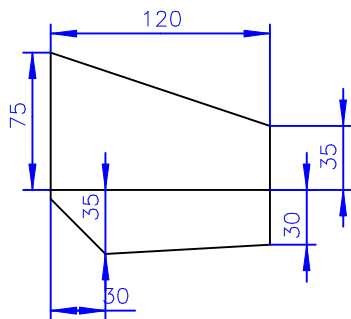

Red Star

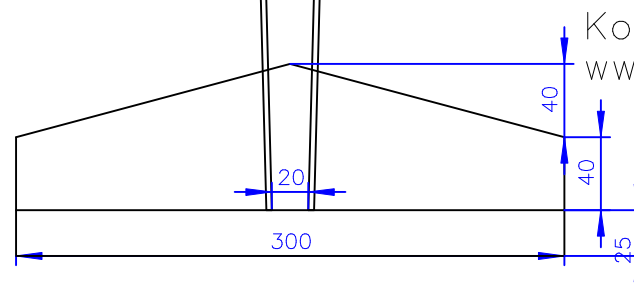

Konstruktion: Johann Irnstetter  
www.Stechflug.com